









OICANDLES

Price List January 2025

OISIDE

OICANDLES COLLECTION	Reference	Description	Dimensions (piece / cm)	Weight (kg)	Pieces (/ Box)	Dimensions (Box / cm)	Volume (m ³)	Weight (kg)	Price (€)
	105931	CANDLES R Rectangular	20 x 30 x 45	1	1	20 x 30 x 45	0,2	1	940
	105932	CANDLES R Round	20 x 50 x 45	1	1	20 x 50 x 45	0,2	1	835
	105933	CANDLES S S	52 x 52 x 19	1	1	52x 52 x 19	0,1	1	710
	105934	CANDLES S M	58 x 58 x 23	1,5	1	58 x 58 x 23	0,2	1,5	730
	105935	CANDLES S L	65 x 65 x 25	2	1	65 x 65 x 25	0,2	2	825
	105936	CANDLES T S	30 x 30 x 35	0,7	1	30 x 30 x 35	0,2	1	435
	105937	CANDLES T M	40 x 40 x 45	0,5	1	40 x 40 x 45	0,2	1	560
ACCESSORIES									
	105938	Led Illumination Unit	13 x 13 x 5	0,5	1				305
		Oi Candle	10 x 10 x 5	0,5	1				27

STRUCTURES

ALUMINUM



Gray
RAL 7030



Graphite
RAL 7021



White
RAL 9003



Brown
RAL 8019



Beige
RAL 1013



Burgandy
RAL 3005



Terracota
RAL 8004



Green
RAL 6003



Beiger red
RAL 3012

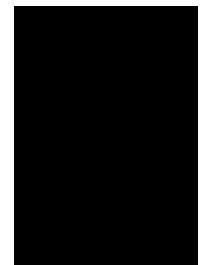

Matt Black
RAL 9005



Gold



Copper

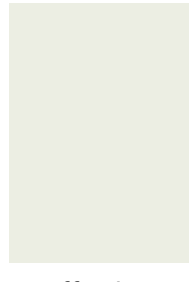

Off-White
RAL 9002



Gray-White
RAL 7044



Blue
RAL 5003



Bronze

LAMP LED BATTERY

Technical characteristics

Battery life / Duración de la Bateria	
Maximum intensity Intensidad máxima	H 11
Medium intensity Intensidad media	H 25
Minimum intensity Intensidad mínima	H 65
Loading time / Tiempo de carga	
De 0 a 100 %	H 5
De 0 a 80 %	H 2
IP Index Índice IP	IP 66
CRI	90
Power Potencia	1,8w

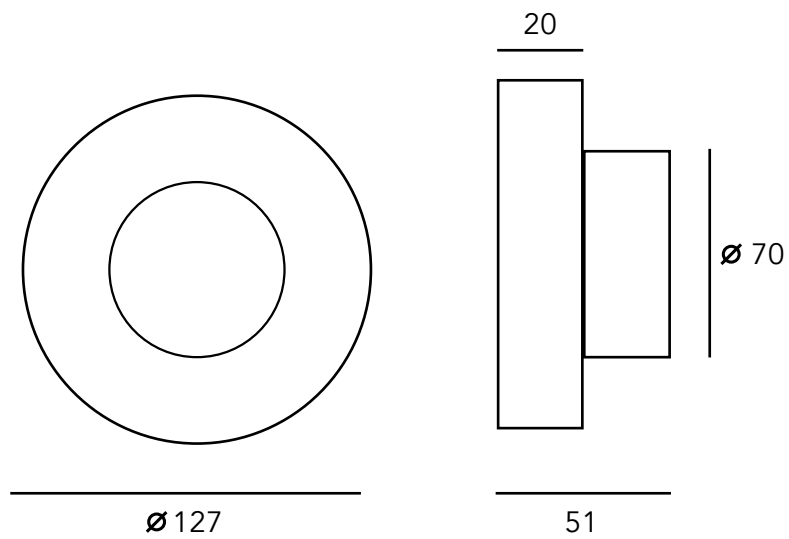



Patio Exterior SL. Polígono Industrial El Saladar
C/ La Morera, 13. 30850 Totana, Murcia. Spain.
968 41 80 83 / oiside@oiside.com