



DESIGNED BY
OISIDE DESIGN STUDIO.

ETERNA

OICOOK

*Enjoy the outdoors with all the
comforts of an indoor kitchen.*



ETERNA is our outdoor kitchen model from the **OiCook** collection with a more industrial, modular and light aesthetic. Its design is based on a single module size, whose structure has a mesh shelf at the base that exposes its entire lower half. This not only accentuates its lighter and more industrial character compared to the other **OiCook** designs, but also makes it more accessible and easier to assemble, even by the user himself.

The design of the Eterna outdoor kitchen module can be customized by leaving the countertop free, as a work surface, or incorporating different cooking elements and a sink.





It measures 120 x 78 cm, so with just two elements you can compose a kitchen of 240cm long with all the basic necessities, including the possibility of adding two drawer unit refrigerators.

Furniture for future.

The countertop, however, is made of MDI porcelain material, available in five different finishes. A material resistant to both the harsh exposure to the weather that an outdoor kitchen experiences as well as cuts, stains and splashes from cooking. It can be equipped with a ceramic hob, barbecue or teppanyaki plate from Barazza, accessories made in AISI 316 thick stainless steel, especially for exteriors.

In addition, one of the most functional, elegant and understated details of Eterna is that the sink is made entirely of stainless steel and incorporates a folding faucet and a lid, allowing it to be kept hidden to take advantage of that space as a surface when its not in use. It also prevents dirt from entering the bucket, an extra feature that is appreciated in an outdoor kitchen.





Furniture for future.

Worktop Module



Sink R&L Module



Teppanyaki R&L Module



Barbacue R&L Module



Ceramic Stove R&L Module



Barbecue + Teppanyaki R&L Module



Double Teppanyaki Module



Teppanyaki + Ceramic Stove R&L Module



Double Barbecue Module



Double Ceramic Stove Module



Barbecue + Ceramic Stove Module



Fridge Module



Barbacue



Barbecue with electric element.

Lava stone included.

Settings 0 to 9.

Maximum absorbed power: 2,4kW.

Equipment: Schuko mains plug.

Waterproof Cover.

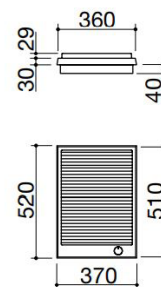

Waterproof cover.

Teppanyaki



2 cooking area.

Electronic temperature control 0 °C to 250 °C.

Hotplate activation indicator and thermostat.

Maximum absorbed power: 3kW.

Equipment: Schuko mains plug.

Waterproof cover.

Thalas chopping board.

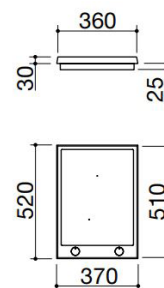

Solid oak wood Thalas chopping board.



Waterproof cover.

Ceramic Stove

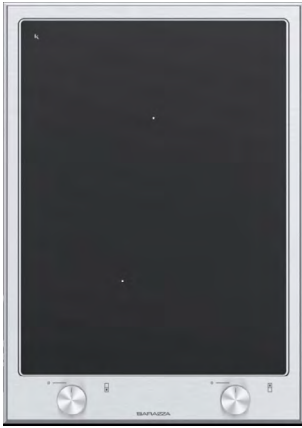

Induction Plaque.

Minimum pan diameter: $\varnothing 90\text{mm}$.

Ajustable power levels: 1,6 - 2,0 - 2,4 - 2,8 - 3,2 - 3,7 kW.

Maximum absorbed power: 3,7kW.

Equipment: Schuko mains plug.

Waterproof Cover.

Thalas chopping board.

Functions: power management, booster, selective pan detection, keep warm, automatic preheating, electronic child safety lock, residual heat indicator, safety switch-off.

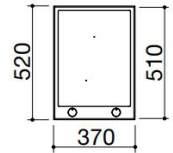
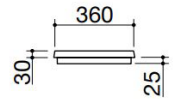

Solid oak wood Thalas chopping board.



Waterproof cover.

Multi-purpose cover

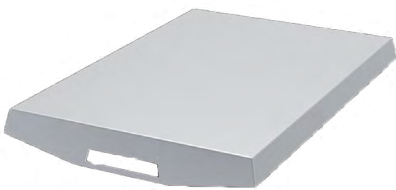

Extra thick AISI 316 stainless steel.

Dual function: cover and serving tray.

Compatible with all kitchen modules.

Compatible with waterproof.

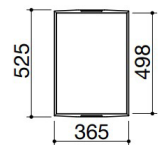
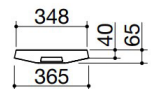

Sink

54x34x18,3 cm Bowl.

Balanced, removable, AISI 316 stainless steel Cover with manual opening.
 Equipment: 3" 1/2 basket strainer waste, B overflow, Thalys telescopic mixer tap with remote control.

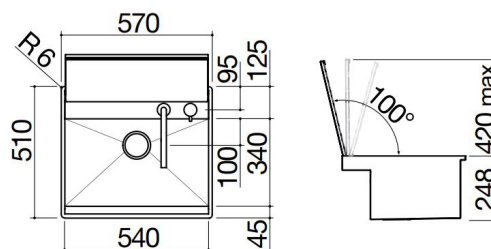

Fridge

Drawer fridge capacity 42 L.

Range of temperature from 0°C to +15° C.

Internal and external walls in stainless steel polished.

Door in stainless steel brushed.

Polyurethane foam insulation thickness 45mm.

Internal LED light with door switch.

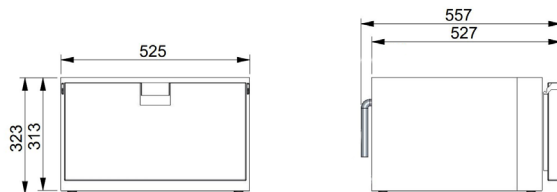

**TECHNICAL
FEATURES**

MDI - MINERAL. DESIGN. INNOVATION.

The structure of the modules is made of aluminium, while its panels and worktop are made of a porcelain material (MDI) available in different finishes, highly resistant both to inclement weather from the outside and to cuts, stains and splashes from cooking.

STONE



Moon

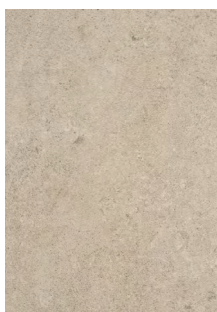

Sand

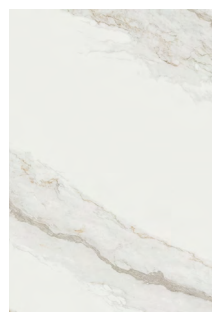

Atenas



Metallo

ALUMINIUM

STRUCTURE



Graphite
RAL 7021



White
RAL 9003

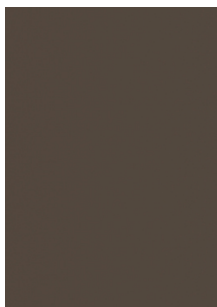

Brown
RAL 8019



Beige
RAL 1013



Gray
RAL 7044



Copper
RAL 8004



Green
RAL 6003

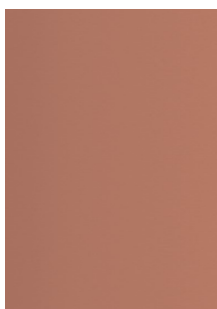

Beiger red
RAL 3012



Matt Black
RAL 9005



Blue
RAL 5003



Gray-White
RAL 9002

SIMPLE KITCHEN

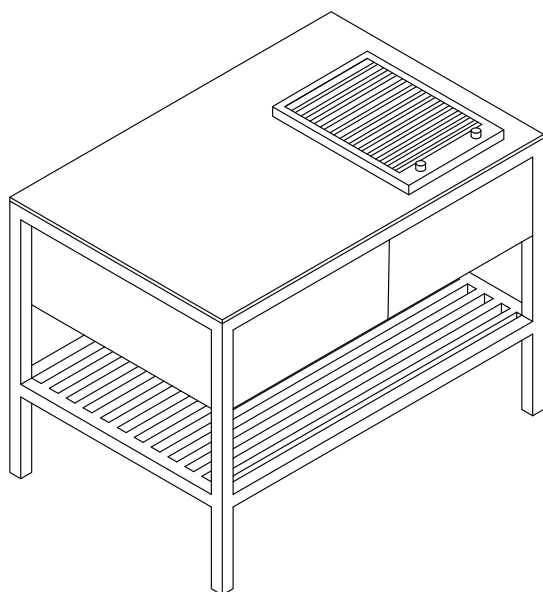

BARBECUE L MODULE

DOUBLE KITCHEN

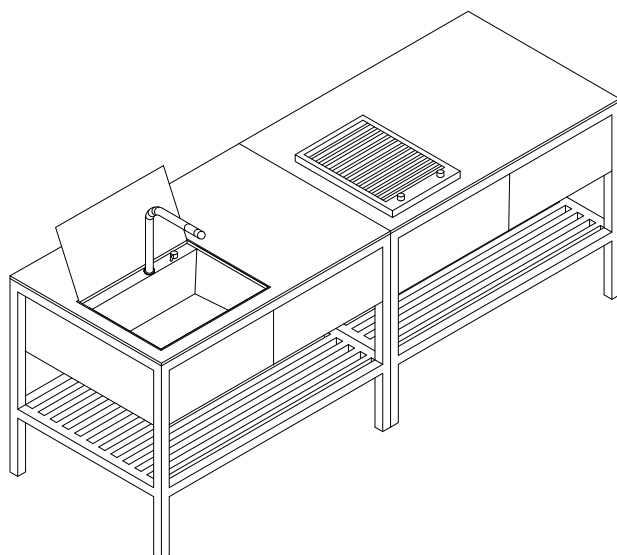

SINK L MODULE



BARBECUE L MODULE

TRIPLE KITCHEN

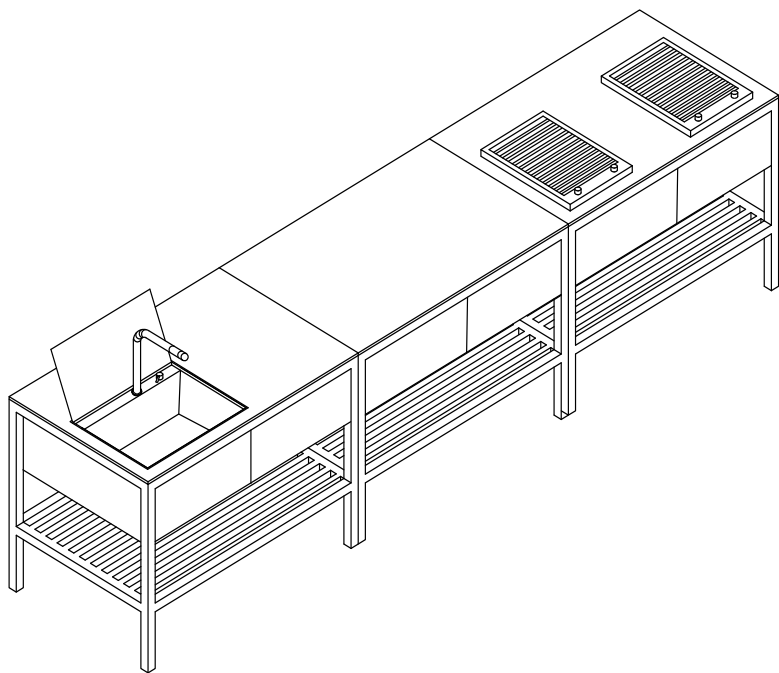

SINK L MODULE



DOUBLE BARBECUE MODULE



WORKTOP MODULE

QUAD KITCHEN

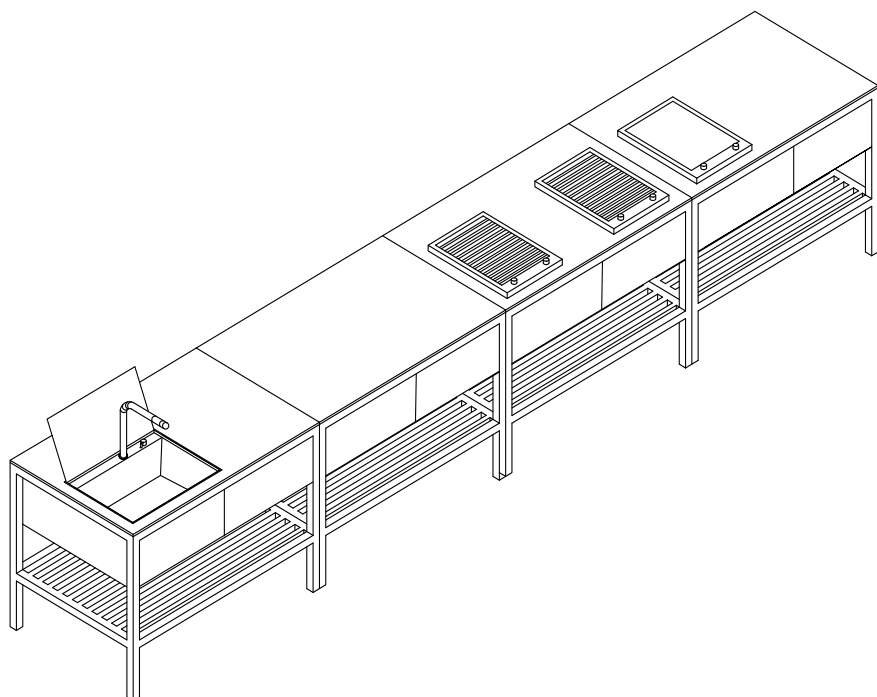

SINK L MODULE



DOUBLE BARBECUE MODULE



WORKTOP MODULE



TEPPANYAKI L MODULE

Furniture for future.

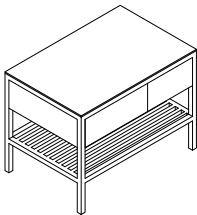
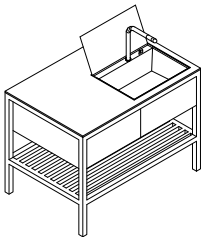
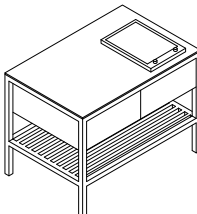
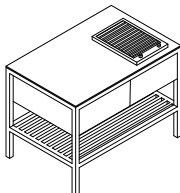
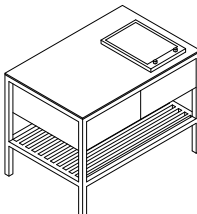
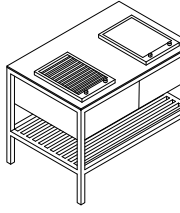
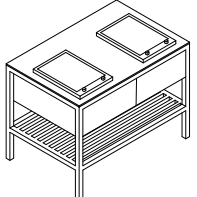
OiCook Collection ETERNA	Reference	Description	Dimensions (piece / cm)	Weight (kg)	Pieces (/ Box)	Dimensions (Box / cm)	Volume (m ³)	Weight (kg)
	150969	Worktop Module	1230x 780x930	±80	1	123x 78 x 100	1	± 80
	150968	Sink R Module	1230x 780x930	±80	1	123x 78 x 100	1	± 80
	150967	Sink L Module						
	150966	Teppanyaki R Module	1230x 780x930	±80	1	123x 78 x 100	1	± 80
	150965	Teppanyaki L Module						
	150964	Barbecue R Module	1230x 780x930	±80	1	123x 78 x 100	1	± 80
	150963	Barbecue L Module						
	150959	Ceramic Stove R Module	1230x 780x930	±80	1	123x 78 x 100	1	± 80
	150958	Ceramic Stove L Module						
	150956	Barbecue L + Teppanyaki R Module	1230x 780x930	±100	1	123x 78 x 100	1	± 100
	150957	Barbecue R + Teppanyaki L Module						
	150954	Ceramic Stove L + Teppanyaki R Module	1230x 780x930	±100	1	123x 78 x 100	1	± 100
	150955	Ceramic Stove R + Teppanyaki L Module						

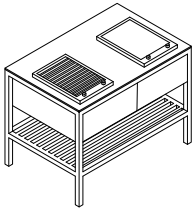

150948 Ceramic Stove L +
Barbecue R Module
1230x 780x930 ±100 1 123x 78 x 100 1 ± 100

150949 Ceramic Stove R +
Barbecue L Module

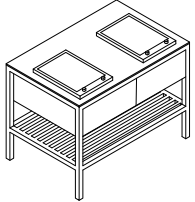

150953 Double Teppanyaki
Module 1230x 780x930 ±100 1 123x 78 x 100 1 ± 100

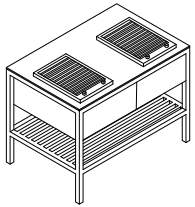

150947 Double Barbecue
Module 1230x 780x930 ±100 1 123x 78 x 100 1 ± 100

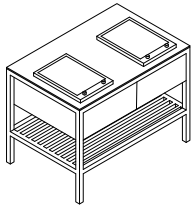

150946 Double Ceramic Stove
Module 1230x 780x930 ±100 1 123x 78 x 100 1 ± 100

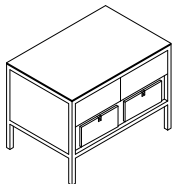

150945 Fridge Module 1230x 780x930 ±120 1 123x 78 x 100 1 ± 120



MORE ABOUT OISIDE DESIGN STUDIO

OISIDE develops its collections in collaboration with talented designers and architects, with the help of its design team. Innovative design both aesthetically and technically, with a sophisticated and timeless look combined with ingenious details. This same team is the same that carries out the research processes for new systems and finishes to improve the resistance of OISIDE materials and upholstery.



ABOUT OISIDE

OISIDE is a Spanish firm specialized in the design and manufacture of outdoor furniture for contract and residential projects. With more than 20 years of experience behind it, OISIDE is a company with a significant international presence that works with architects and designers from all over the world. The production of its collections is carried out entirely in Spain through expert manufacturing of the highest quality that allows OISIDE to offer a high degree of customization through its designs.