

# ELEMENTS

*A collection of modular furniture that,  
with only three pieces, allows you to  
create multiple combinations.*



The Elements collection can be easily reconfigured, adapting to the functional or spatial needs of each moment. By its design, with deep and low height seats, it is a collection perfect for designing rest areas.

Elements design is technically developed so that the different furniture options modular that allows you to create versatile and agile staking out. Modules are linked together with a hook that fixes the pieces at the bottom. A hidden connection, very easy to use, that allows to reconfigure the parts simply by lifting the modules and separating them from the hooks.

The combinations that can be achieved with Elements are innumerable: from individual armchairs, chaise longues or sun loungers, to two-seater sofas or the desired length and depth.

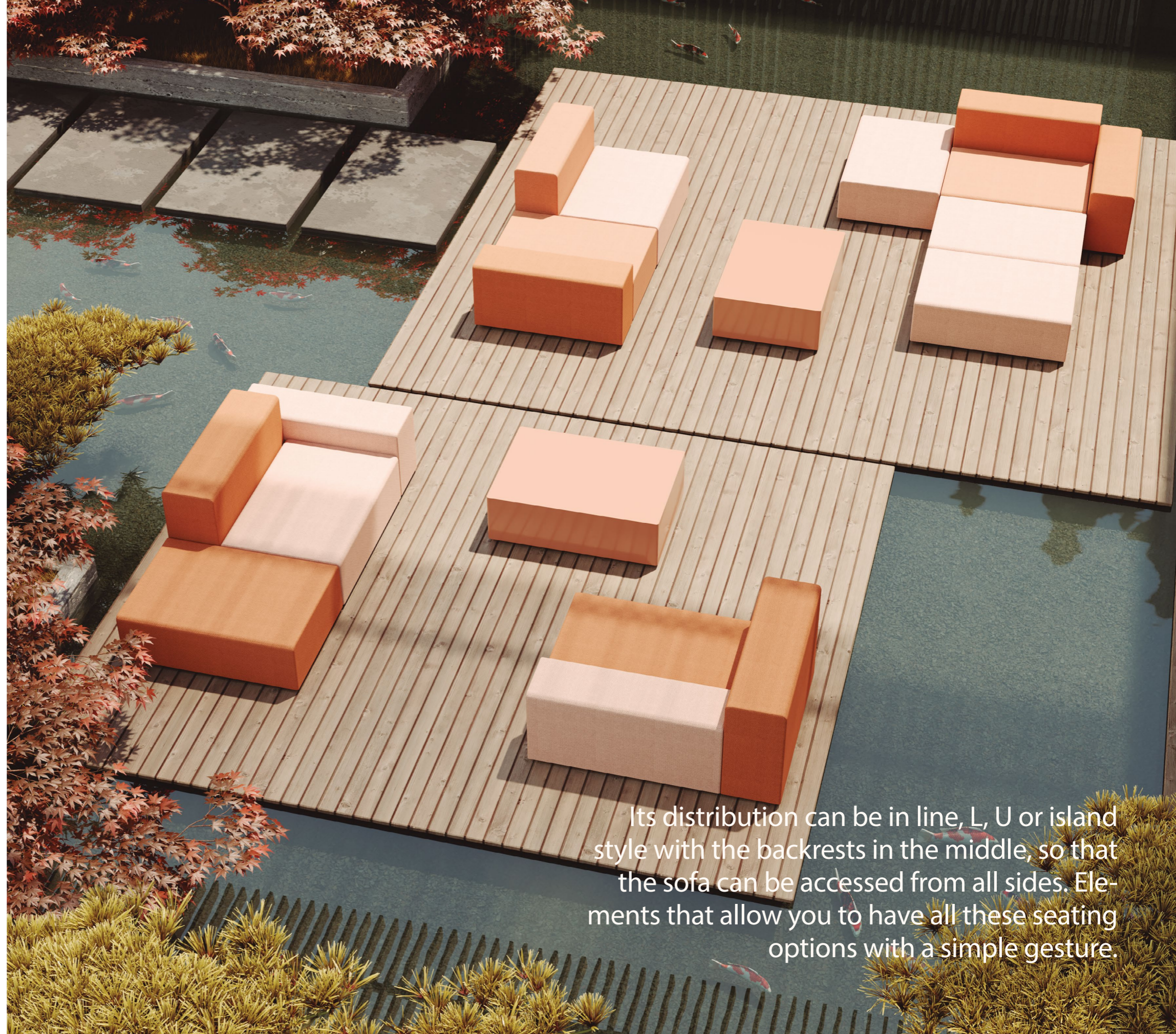





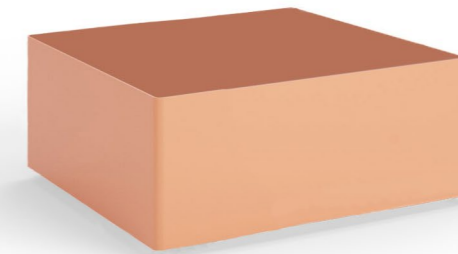

Its distribution can be in line, L, U or island style with the backrests in the middle, so that the sofa can be accessed from all sides. Elements that allow you to have all these seating options with a simple gesture.



The collection is completed with a square and a rectangular side table, available with an aluminum structure and an HPL tabletop, customizable in any shade of the RAL chart or with Dekton envelopes. The rectilinear and monolithic appearance of this collection of modular furniture contrasts with the sensation of lightness provided by the recessed skate of its bases and with the comfort of its seats, achieved with a filling of three types of foams with a wadding finish.



ELEMENTS COLLECTION	Reference	Description	Dimensions (piece / cm)	Weight (kg)	Pieces (/ Box)	Dimensions (Box / cm)	Volume (m <sup>3</sup> )	Weight (kg)
	160061	Oi Base Module 1	100 x 70 x 35	15	1	100 x 70 x 35	0,3	15
	160064	Oi Base Module 2	70 x 200 x 35	30	1	200 x 70 x 35	0,5	30
	160063	Oi Armrest Module 3	30 x 100 x 45	11	1	30 x 100 x 45	0,1	11
	160062	Oi Backrest Module 4	100 x 30 x 65	12	1	100 x 30 x 65	0,2	12
	160069	Oi Rectangle Coffee Table 100	100 x 50 x 35	25	1	100 x 50 x 35	0,2	25
	160070	Oi Square Coffee Table 70	70 x 70 x 35	24	1	70 x 70 x 35	0,2	24

## MODULAR CONFIGURATION

### BUILDING MODULES :

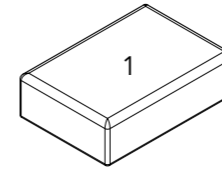

Base Module 1  
Ref:160061

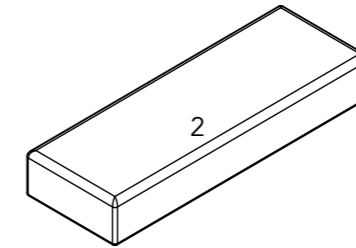

Base Module 2  
Ref:160064

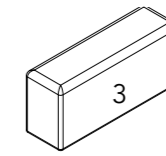

Armrest Module 3  
Ref:160063

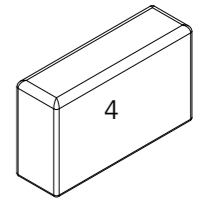

Backrest Module 4  
Ref:160062

### MODULAR CONFIGURATION SAMPLES

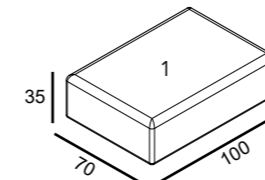

Configuration A.

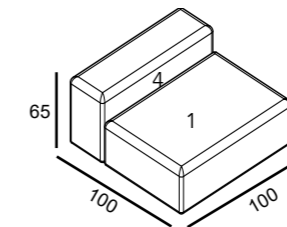

Configuration B.

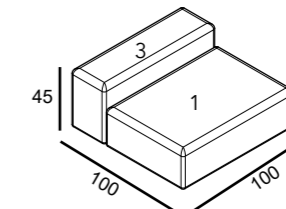

Configuration C.

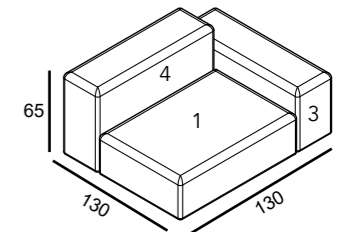

Configuration D.

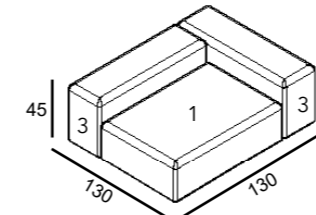

Configuration E.

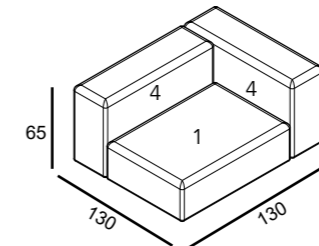

Configuration F.

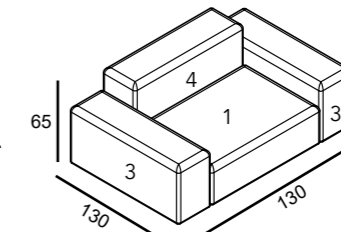

Configuration G.

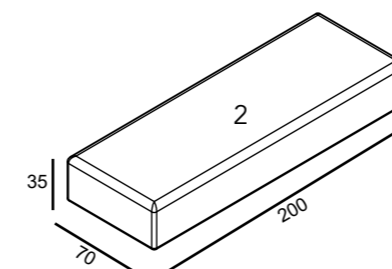

Configuration H.

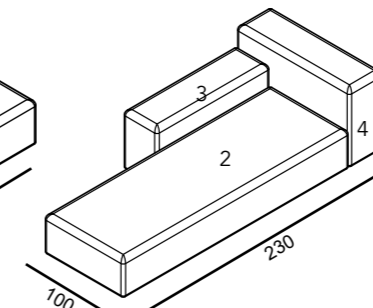

Configuration I.

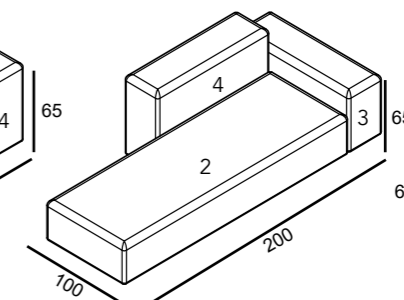

Configuration J.

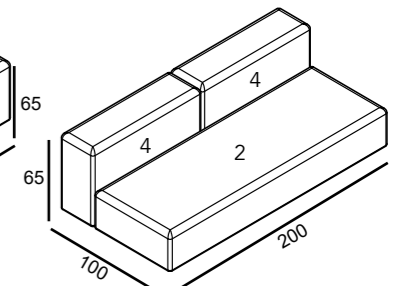

Configuration K.

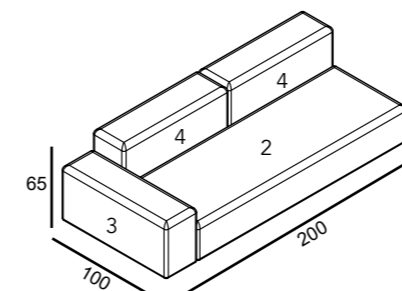

Configuration L.

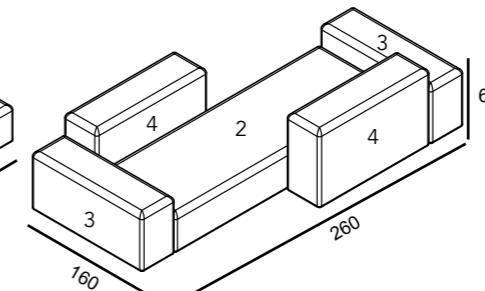

Configuration M.

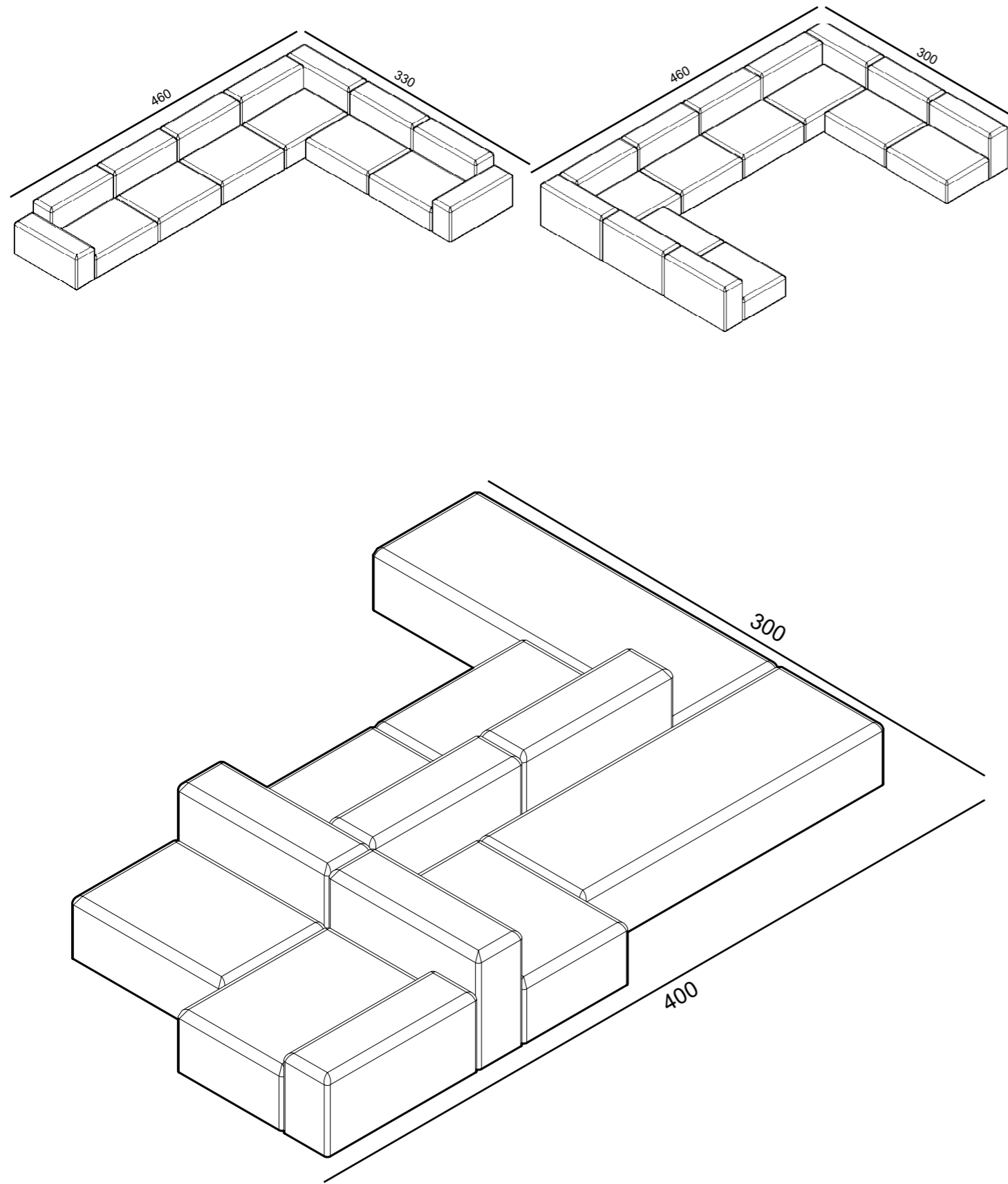

MATERIALS AND FINISHES

OUTDOOR FABRICS

HITCH

					
Alloy HIT-8960	Avalanche HIT-8963	Orange HIT-8911	Carbon HIT-8904	Cerulean HIT-8998	Ciruela HIT-8995
					
Freesia HIT-8990	Iceberg HIT-8962	Lava HIT-8915	Java HIT-8920	Lakritz HIT-8988	Indigo HIT-8918
					
Lead HIT-8957	Limeade HIT-8922	Mahogany HIT-8953	Meteorite HIT-8901	Neutra HIT-8916	Pastel HIT-8900
					
Platinum HIT-8903	Porcelain HIT-8999	Putty HIT-8912	Raisin HIT-8994	Sapphire HIT-8914	Seashell HIT-8964
					
Starfish HIT-8965	Sunflower HIT-8909	Tangerine HIT-8991	Zest HIT-8913	Zinc HIT-8961	

OUTDOOR FABRICS

AGORA



TECHNICAL FILE

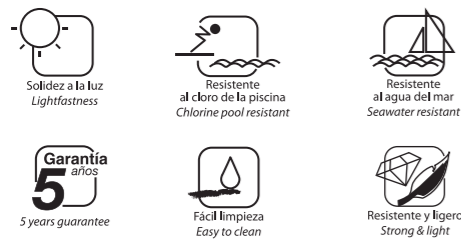

TECHNICAL FILE: CARACTERÍSTICAS GENERALES	
Composition / Composición:	100% Solution Dyed Acrilyc.
Weight / peso:	300gr/m2
Finish / Acabado:	Teflon with stain and mildew resistant treatment. Teflón con tratamiento antimanchas y antihongos.
Other features / Otras características:	Avoid condensation from hot and humidity. Good oil repellency. Evita la condensación de calor y humedad. Buena repelencia al aceite.
Light fastness / Solidez a la luz:	7/8
Tolerance / Tolerancia:	Sensitive values of tolerance of +/- 5%. Valores susceptibles de tolerancia de +/-5%.
Cleaning instructions / Manutención:	

OUTDOOR FABRICS

OiPets 200



OiPets 300



OiPets 400



Technical File

OIPETS	200	300	400
Composition Composición	100% Acrylic Solution Dyed 100% Acrílico tintado en masa		100% Acrylic Solution Dyed 100% Acrílico tintado en masa
Weight Peso	220 gr / 270 gr	340 gr	400 gr
Finishes Acabados	Water repellent with nanoparticle technology / Anti bacteria / Anti mold Repelente al agua con tecnología nanoparticulas / Anti bacterias / Anti moho		Water repellent with nanoparticle technology / Anti bacteria / Anti mold Repelente al agua con tecnología nanoparticulas / Anti bacterias / Anti moho
Treatments Tratamientos	Active virus inhibition (covid-19) / Self-cleaning / Air purifier eliminating pollution / UV protection / Elimination of odors / Bactericidal effect / Antistatic Inhibición activo de virus (covid-19) / Autolimpieza / Purificador del aire eliminando contaminación / Protección UV / Eliminación de olores / Efecto bactericida / Antiestático		Active virus inhibition (covid-19) / Self-cleaning / Air purifier eliminating pollution / UV protection / Elimination of odors / Bactericidal effect / Antistatic Inhibición activo de virus (covid-19) / Autolimpieza / Purificador del aire eliminando contaminación / Protección UV / Eliminación de olores / Efecto bactericida / Antiestático
Light fastness Solidez a la luz	4/5 (Grey Scale) 4/5 (Escala de grises)	7/8 (Blue Scale) 7/8 (Escala de grises)	4/5 (Grey Scale) 4/5 (Escala de grises)    7/8 (Blue Scale) 7/8 (Escala de grises)
Martindale	30.000 Cycles 30.000 Ciclos		30.000 Cycles 30.000 Ciclos
Cleaning instructions Instrucciones limpieza			

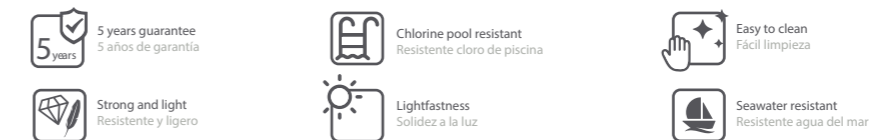

STRUCTURE

Aluminium



TABLE TOP



MORE ABOUT  
OISIDE DESIGN STUDIO

OISIDE develops its collections in collaboration with talented designers and architects, with the help of its design team. Innovative design both aesthetically and technically speaking, with a sophisticated and timeless appearance combined with ingenious details. This same team is the same one that carries out the research processes on new systems and finishes to improve the resistance of OISIDE materials and upholstery.



ABOUT OISIDE

OISIDE is a Spanish firm specialized in the design and manufacture of outdoor furniture for contract and residential projects. With more than 20 years of experience behind it, OISIDE is a company with a significant international presence that works with architects and designers from all over the world. The production of its collections is carried out entirely in Spain through expert manufacture of the highest quality that allows OISIDE to offer a high degree of customization through its designs.